

VortexPro

Características Generales de Generación Eléctrica: Generador Eólico Vertical, VortexPro

El Generador Eólico vertical, VortexPro contiene un sistema que trabaja por medio de electroimán.
 Cuenta con un alternador síncrono el cual es capaz de transformar energía mecánica en eléctrica.
 Transforma el viento en energía con alta potencia.
 El VortexPro ajusta automáticamente su velocidad y dirección.
 Su diseño es novedoso, compacto, ligero, mayor duración y estabilidad.
 Se lubrica por medio de grasa.
 Mayor resistencia a la oxidación.
 Mayor estabilidad.
 El material de las cuchillas es aluminio de alta calidad.
 Facilita su instalación, mantenimiento y reparación.
 Funciona con una brisa de viento.
 Soporta velocidades de hasta 162 Km/h.
 Poste se vende por separado, se sugieren postes de 8m hasta 10m de altura dependiendo los vientos.

Aplicaciones de Generación Eléctrica: Generador Eólico Vertical, VortexPro

El VortexPro es ideal para zonas industriales, espacios públicos, centros comerciales, ranchos de ganadería, hospitales, escuelas, edificios, restaurantes, hoteles, barcos, oficinas, granjas, haciendas, fincas, huertas, etc.

Garantía de Generación Eléctrica: Generador Eólico Vertical, VortexPro

El VortexPro, cuenta con 1 año de garantía sujeto a clausulas VentDepot.



Características Técnicas de Generación Eléctrica: Generador Eólico Vertical, VortexPro																
Clave	Potencia del Generador	Voltaje de Salida	Velocidad del Viento		Velocidad Mínima para Funcionamiento		Velocidad Máxima del Viento		Turbina		Temperatura	Peso Kg	Dimensiones con Empaque de Cartón en cm			
			m/s	Km/hr	m/s	Km/hr	m/s	Km/hr	Diámetro Ø	Altura m			Ancho	Alto	Largo	
MXVTP-001	300 W	12 V	11	40	1.5	5.4	45	162	0.63	1.35	-40°C a 80°C	20.5	40	140	40	
MXVTP-002	300 W	24 V	11	40	1.5	5.4	45	162	0.63	1.35	-40°C a 80°C	20.5	40	140	40	
MXVTP-003	400 W	12 V	11	40	1.5	5.4	45	162	0.63	1.35	-40°C a 80°C	21	40	140	40	
MXVTP-004	400 W	24 V	11	40	1.5	5.4	45	162	0.63	1.35	-40°C a 80°C	21	40	140	40	





VortexPro

Dimensiones de Generación Eléctrica: Generador Eólico Vertical, VortexPro

Clave	Ø A	Ø B	C	D
MXVTP-001	660	200	1100	1220
MXVTP-002	660	200	1100	1220
MXVTP-003	660	200	1300	1450
MXVTP-004	660	200	1300	1450

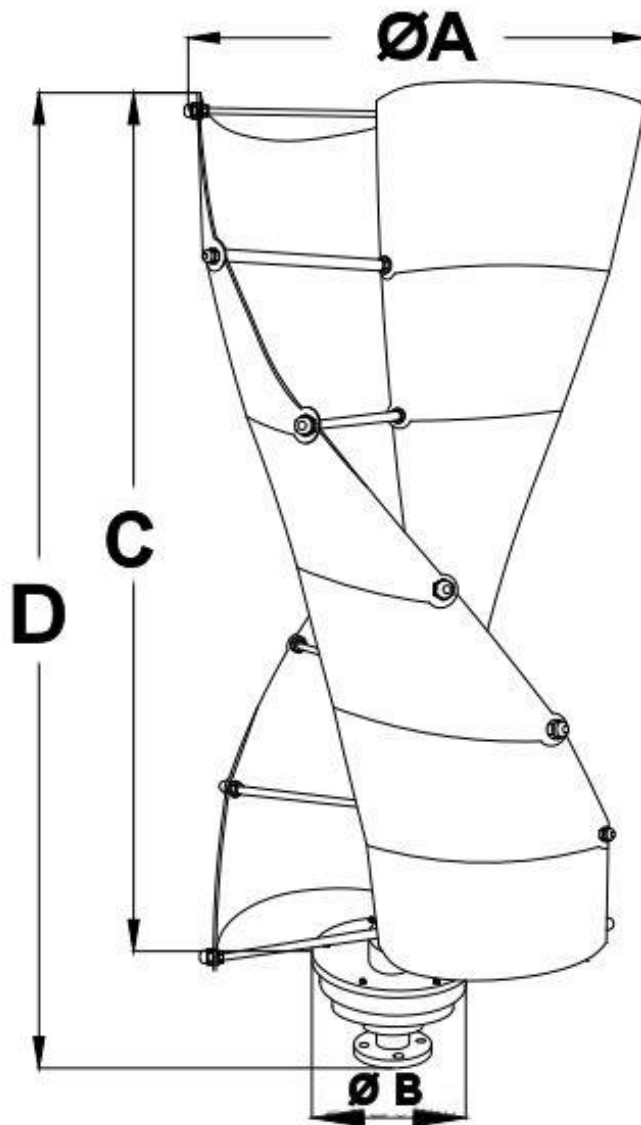

VortexPro

Aplicaciones de Generación Eléctrica: Generador Eólico Vertical, VortexPro





VortexPro

Sistema On-Grid



Sistema Off-Grid





Velocidad Media Global del Viento, VortexPro

Global Mean Wind Speed at 80m

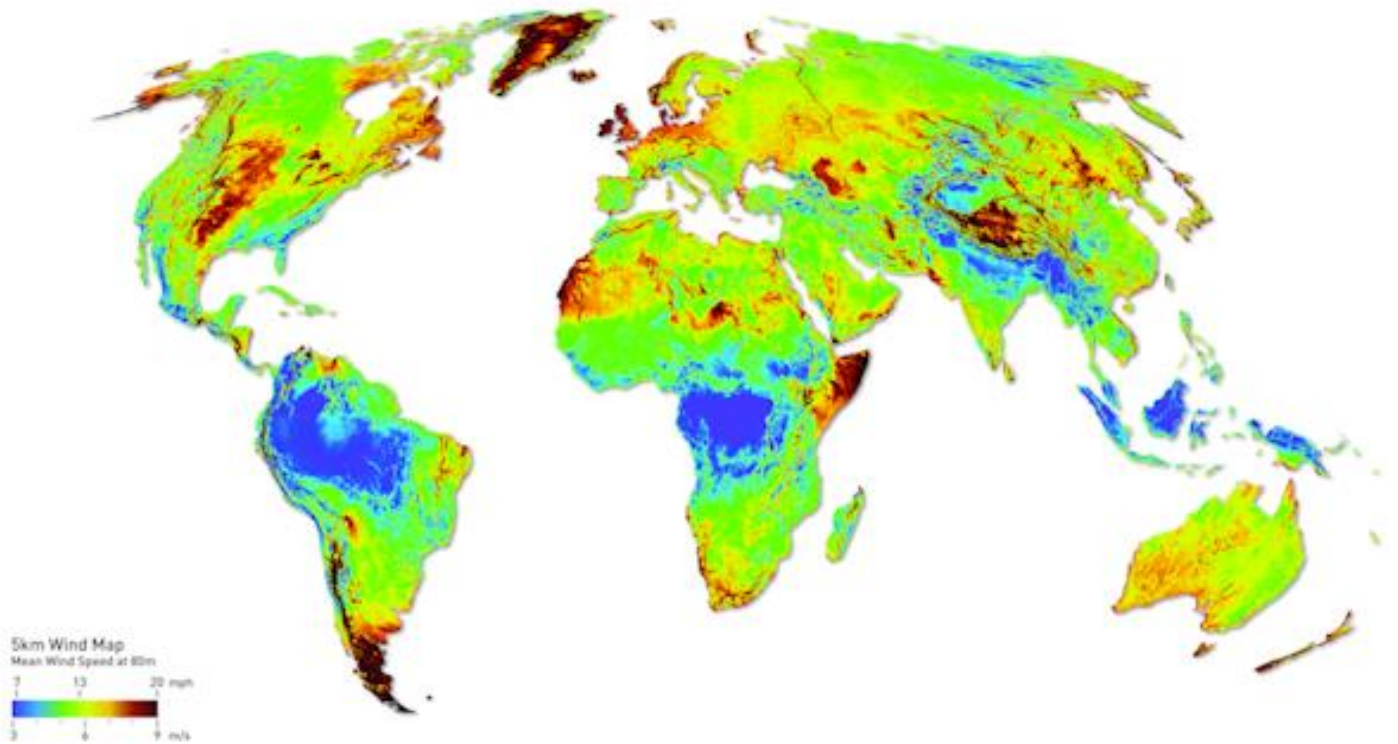



USER MANUAL

For S Model Vertical Wind Generator

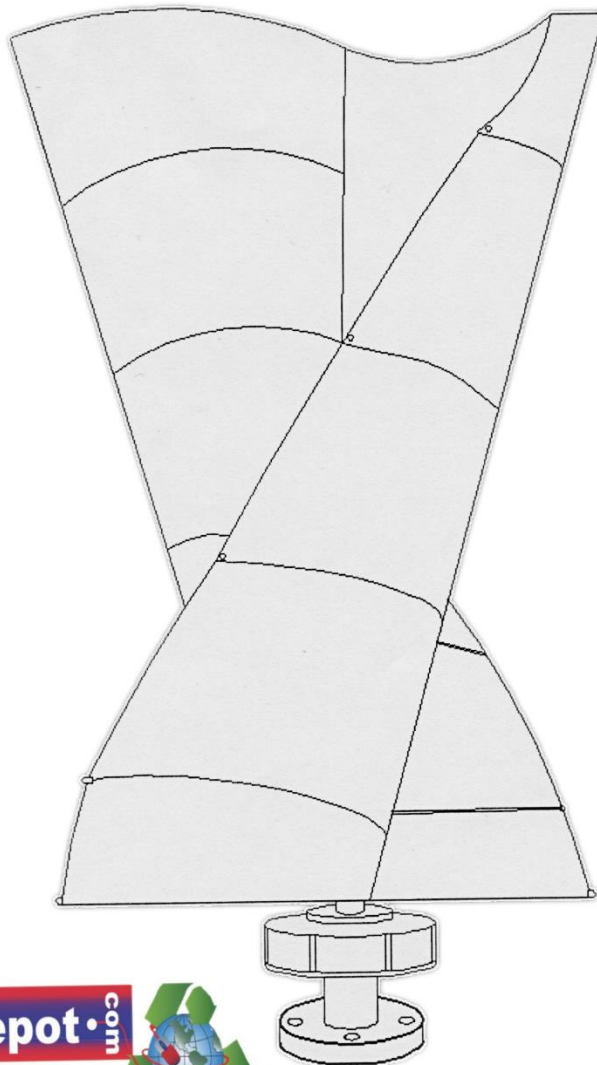

Introducción

Distinguished Users:

We are very glad that you choose our company's products and feel sure that you will find the convenience that our products bring to you and the joy of promoting the policy of "low carbon and environmental protection".

Please do not forget to read the "User Installation Manual" before installing of the products.

Catalog

Part1. Safety Warning and the Attention -----3

Part2. Product Description-----5

Part3. Tower and Accessories Production----- 7

Part4. The wind generator Installation Steps----- 9

Part5. The Connection between Transmission Line and the Controller----- 10

Part6. The Maintenance and Attention in Operation----- 11

Part7. Packing list-----12

Part8. Quality Guarantee-----13



Part1. Safety Warning and the Attention



Attention:

For correct installation and use of this equipment, please read carefully the safety warning and attention and strictly follow the instructions.

Basic requirements:

- Do not disassemble the equipment by you. Please contact the specified maintenance department when the equipment is out of order.
- Without authority, no company or individual are allowed to change the equipment structure, safety and performance design.
- please obey local laws and regulations when using this product.

Assembly Requirements:

1. Before the assembly of the wind generator or in the process of maintenance, please be sure to read the user's manual first.
2. Please don't install the wind generators in rainy days or when the wind scale is at Level 3 or above.
3. After opening the package, it is advised to short circuit the three leads of the wind generators (the exposed copper parts should be screwed together).
4. Before the installation of the wind generator, lightning grounding must be prepared. You can arrange the facilities according to national standards, or you may arrange them according to the local environment and soil condition.





Requisitos de Montaje

5. When assembling the wind generator, all the parts should be fastened with fasteners specified in table2

Table 2

Serial#	Fasteners	spec	quantity	tightening torque (N*M)	remarks	Executive standard
1	Flange bolts	M12*45	4	45-55	galvanized	
2	Plain washer	D12.2	8		galvanized	
3	Spring washer	D12.2	4		galvanized	
4	Nuts	M8	48	12-15	galvanized	
5	Connecting rod	M8	6	12-15	galvanized	
6	Screw	M8	12	12-15	stainless	
7	Nuts	M12	4	45-55	galvanized	

6. Before the connection between the wind generator flange and the tower flange, please connect the three leads of the wind generator to the three leads of the tower accordingly.

When using the hinge method, every pair of wires should be no less than 30mm in length and be wrapped with Acetate cloth tape for three layers, then sheathed with spun glass paint tube. With this method, connect the three pairs of wires (attention: the joint of the wires can't bear the weight of the tower leads directly, so wires 100mm downward from the joint should be wrapped with adhesive tape and then stuffed into the steel pipe. After that, wind generator flange and tower flange can be connected.

7. Before hoisting the wind generators, the end (which should be connected with controller) of the tower lead should be cut away the insulating layer for 10mm or so. Then screw the three exposed leads (short circuit) together.

8. During the installation, it is prohibited to revolve the rotor blades roughly (the ends of wind generator leads or the tower leads are short-circuited at this moment). Only after all





Descripción del Producto

the installation and the examination is finished and the security of the erection crew is guaranteed, it is allowed to dismantle short circuited leads and then connect with controller and battery before running.

Attention:

Battery should be connected with controller before wind generator connected with controller

If above stated instruction are not followed when assembling and installing the wind generators, we are sorry that any problem or failure resulted are not to be covered by warranty.

Part2. Product Description

1. Low start up speed; high wind energy utilization; beautiful appearance; low vibration
2. Human friendly design, easy installation, maintenance and repair.
3. Precise injection molding blades together with the optimized design of aerodynamic contour and structure, the blades have such advantages: high utilization of wind energy which contributes to the annual energy output.
4. The generators, adopting maglev alternator , with a special kind of stator design, efficiently decrease resistance torque. Meanwhile, it makes the wind generators match the generators quite well and increase its reliability.





Part3. Tower and Accessories Production

1. Its flange base is suggested to be installed on a free standing tower whose O.D. is 85mm and thickness is 16mm.

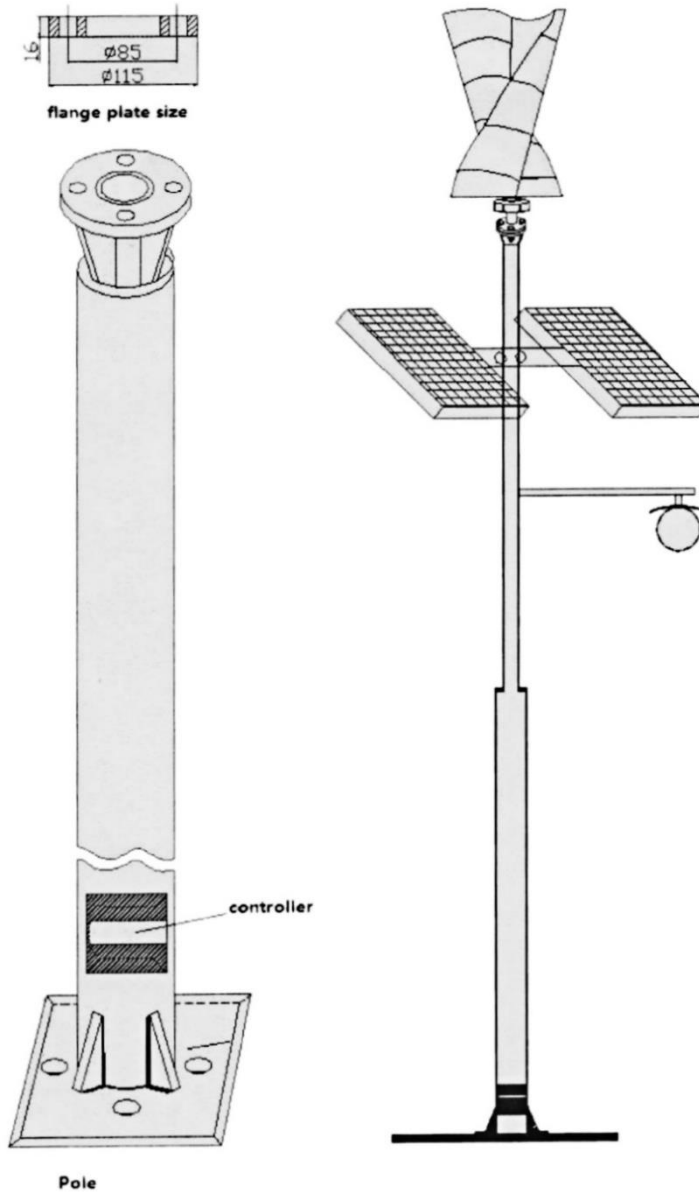

2. Iron pipe length is suggested to choose based on local wind scales and geographical environment.





Pasos de instalación del Generador Eólico

Part4. The wind generator Installation Steps

 It is prohibited to assemble and install wind generators in rainy days.

1. The insulated current transmission wires: transmission lines are built in the iron pipe tower. The upper end is led out through the center bore of the wind generator flange, while the bottom end are led out from the pipe opening which is 30cm away from the ground.

The section from the opening to the point which is 60cm beneath ground should be protected by iron pipes who's O.D should be 17mm to 21mm. The underground paths of the transmission lines to the controller can make arrayed and covered with iron pipe or a plastic pipe.

2. The installation sequence of the wind generators can follow the steps as illustrated in video.

2-1. Place the steel bracket on the ground; block up the flange joint to 1.3m.

2-2. Align the wind generator flange to the tower flange. Cut away insulating layer of current transmission wire end (which are to be connected with controller) for 10mm, then short circuit the exposed copper wires (screwed together)

3. The lifting of the wind generators and tower should be proceeded with the presence of skilled slinger and the security should be guaranteed. The tower's stance should be executed on the basis of the relevant requirement of permanent construction.

4. After installation of tower and lightning protection is finished, use 500V meggar to measure insulating resistance between transmission lines and earth (earth wire can act as





VortexPro

Partes del Generador Eólico

ground) in the case of not losing the short circuited leads of transmission lines, measurement should not be less than $5M\Omega$, otherwise, insulating layer may be crushed or damaged should be dealt with immediately.

Figure 3

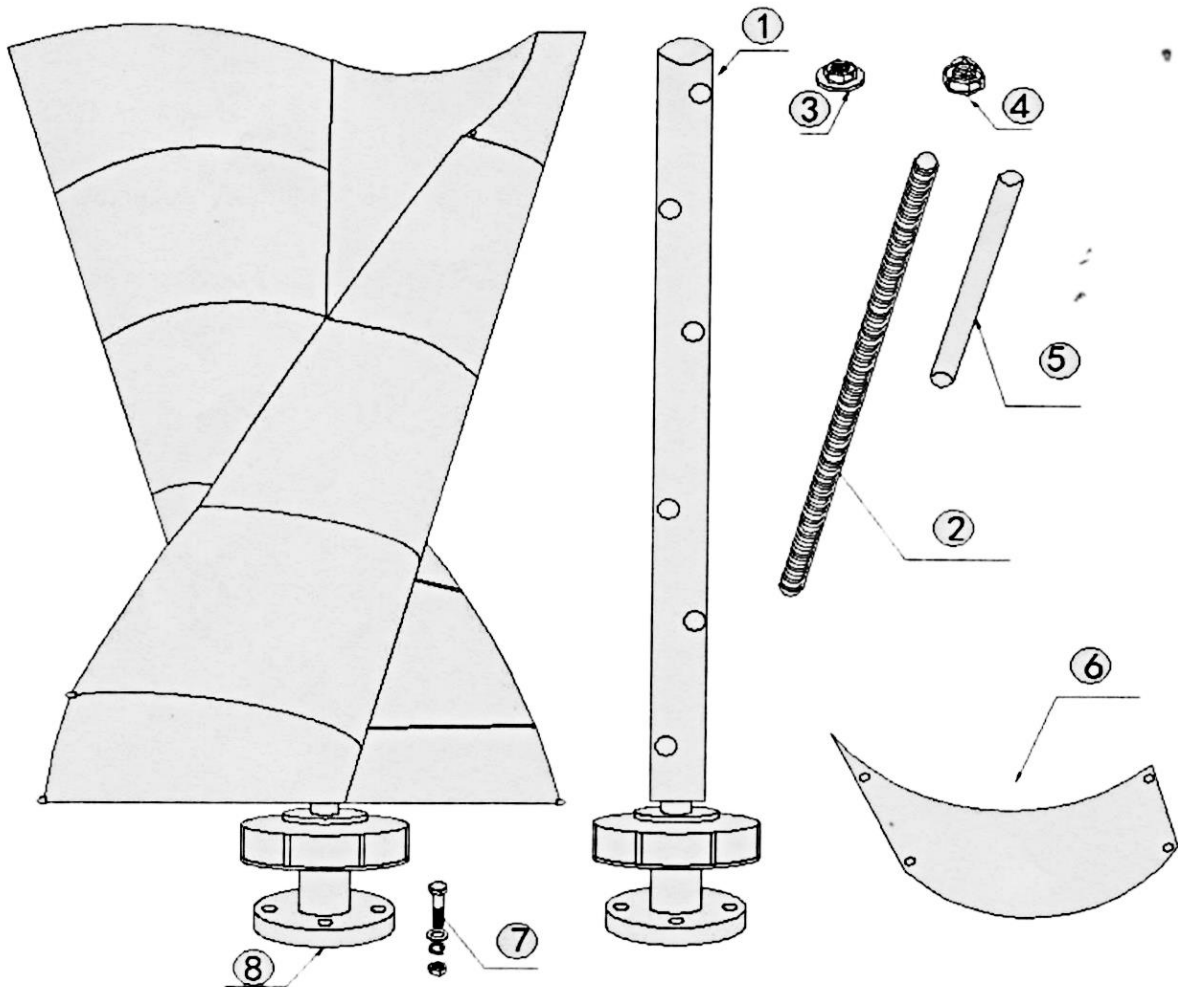

wind generator decomposition





Conexión de la línea de transmisión con el controlador

Part5. The Transmission Line Connection With Controller



Avoid heavy rain days for the first commissioning. Priority should be given to the days with gentle breeze or strong wind (wind speed: 5~13m/s).

1. Connect correctly the positive and negative pole of battery to the positive and negative pole of controller.
2. The load circuit connected to the socket on the back of control by way of fuses, switches, plugs.
3. Connect the three current transmission lines of wind generator to the three terminals on the back of controller. Please refer to controller manual for detailed instruction.
4. Battery selection generally lead-acid battery preferred, 100w-.300W wind generator 100AH -200AH battery optional, 300W-600W wind generator, 200 ~ 400AH battery optional.
5. The controller should be placed in dry, well ventilated place, moisture and dust-proofed. Inverter shell should be kept grounded and more than 1.5 meters away from the batteries to avoid acid gas pollution.
6. Battery should be put in the dry, ventilated place, cool in summer, warm in winter, in such environment , battery can be better maintained

Attention:

- Battery should be connect with controller before wind generator connected with controller.
- Failure to follow these written instructions will void your product guarantee.





Mantenimiento y Precauciones

Connection diagram of wind generator, solar panel & electrical appliance

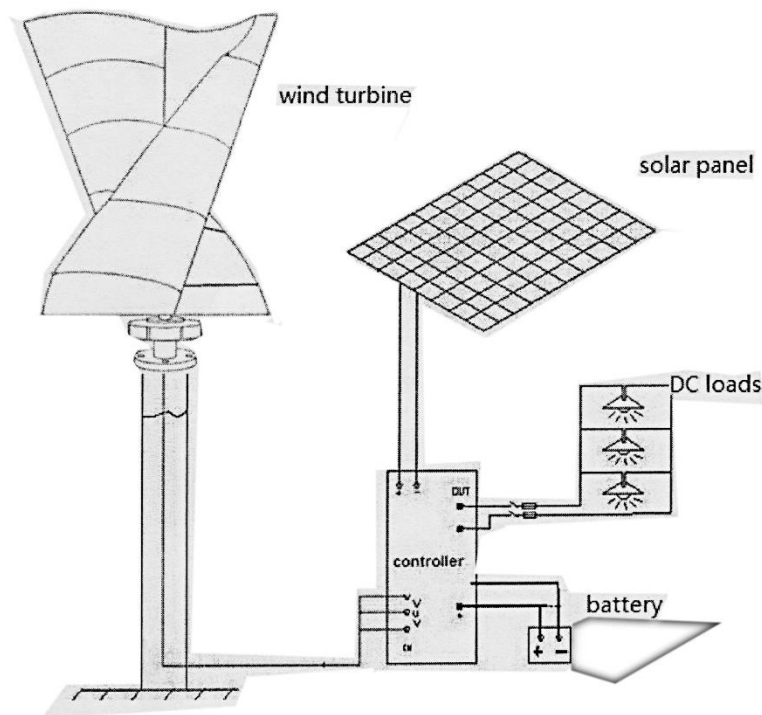

Part6. Maintenance and Precautions ⚠

1. Wind generators often work at poor environment, thus please make sure to check regularly with your sight and hearing; check whether the tower is swaying or whether the cable is loose (using a telescope is also a good idea).
2. Timely inspection should be made after a heavy storm. If there is any problem, please put down the tower slowly for maintenance. With regard to the wind generators for streetlights, there should be electrician climbing the pole to check if there is any problem when wind generator have been short circuited and security protection measures prepared.
3. The free maintenance batteries should be kept externally clear.
4. Do not disassemble the equipment by yourself. Please contact sales department when the equipment is out of order



**Part7. Packing List** 

Serial#	Item	Quantity	Remarks
1	Generator body	1	
2	blades	10/12/8	
3	Bolts and nuts	1 bag	
	Connecting rods	6	M8
	Stainless rods	12	
13	L spanner	1	optional
14	hex wrench	1	optional
15	Controller / inverter	1	optional
16	tower	1	optional

Part8. Quality Guarantee

1. The company guarantees customers that generator is of excellent quality, function is good, the body is complete, rigorously checked before delivery.
2. We provide one year's warranty for wind generator since the date of sale, damages occurred in the following situation: dismantle by yourself or seriously violate operation (not according to instructions use) are not covered by warranty.
3. The documents are as a product warranty certificate, please keep it properly.





VortexPro

Descripción Gráfica de la Instalación

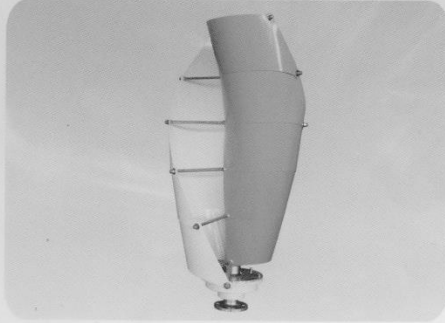

1、 Check the package and then check the wind turbine for damage after unpacking. Damaged wind turbine cannot be installed in the system.

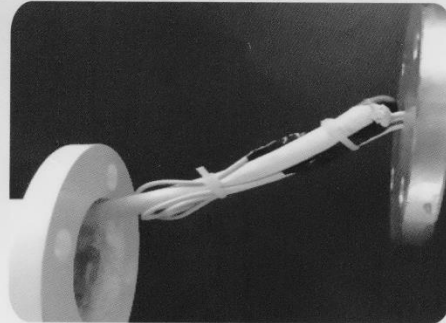

2、 Connect three wires of wind turbine to the transmission cable, each length of the spliced wire is at least 30mm; fasten the connectors with tape, the length is about 100mm.(as above picture shows)



3、 Install the flange plate of wind turbine on the flange seat of tower; install flat gasket and elastic gasket, tighten the nut.

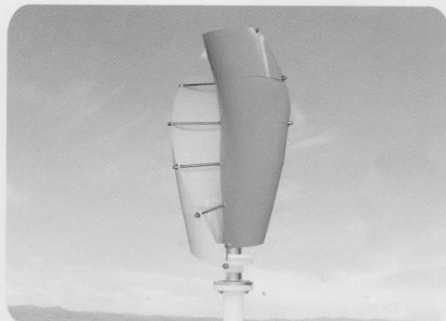

4、 Before the three wires connecting to the charge controller, please connect the batteries to the controller.

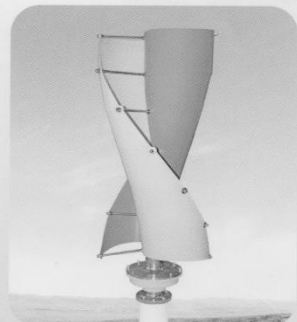
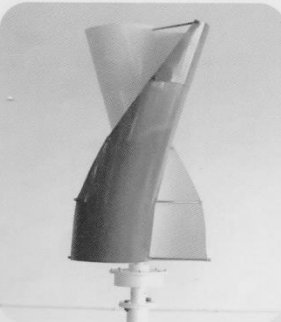

suitable for 8 blades, 10 blades and 12 blades of spiral wind generator

PS:The above information is for reference only, detailed installation information to See the INSTRUCTION.

